



## PARTS & SERVICE

**Air conditioning system**

**Spare parts list**

**CC170**

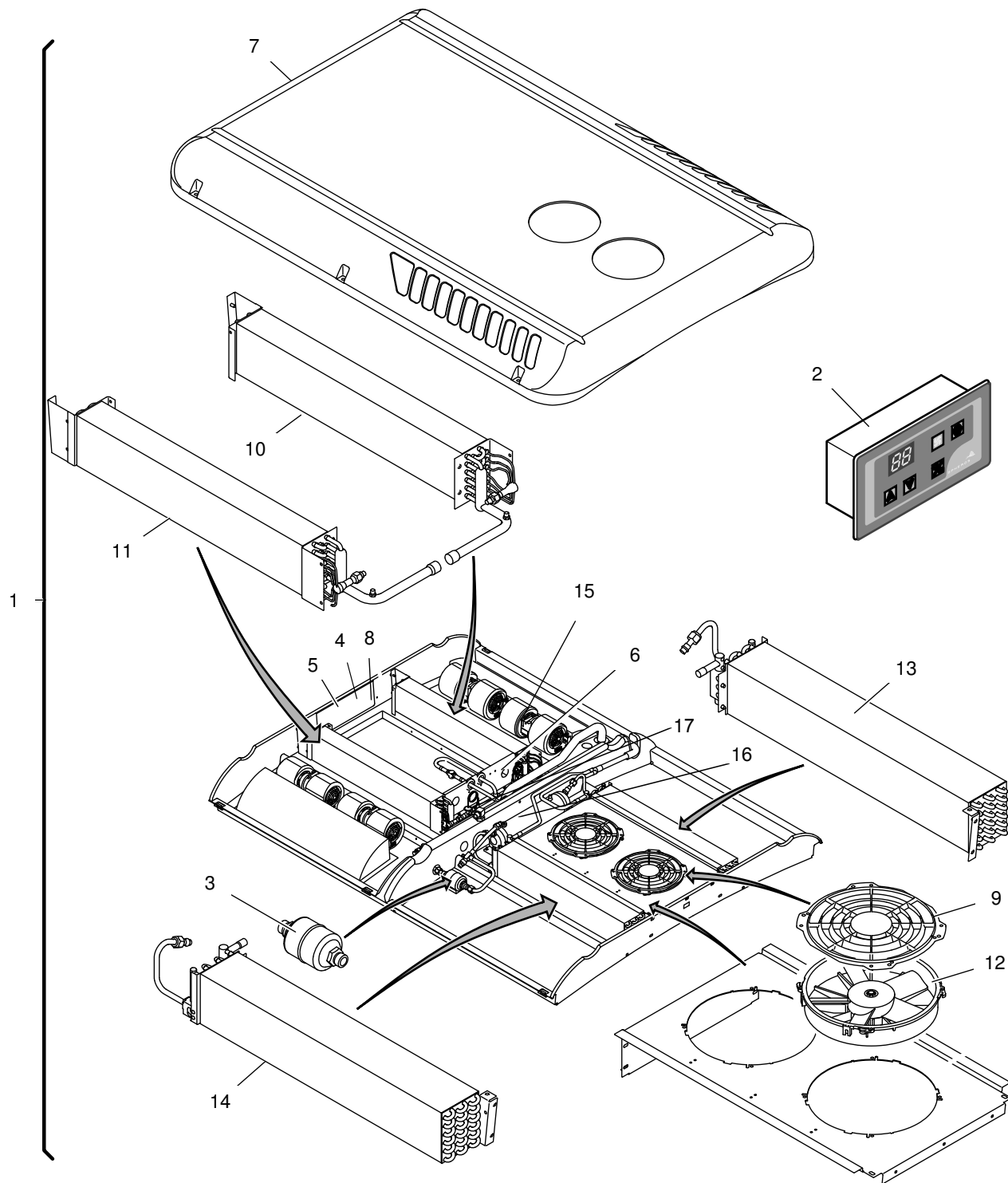

18



19



20



21



22



23

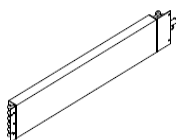

24

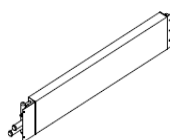

25

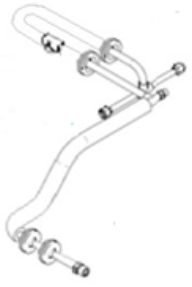

26

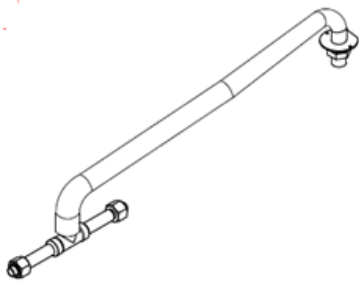

27

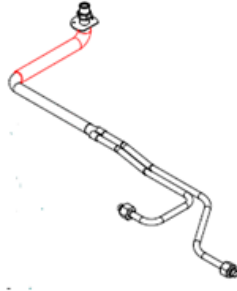

28



29



30



31

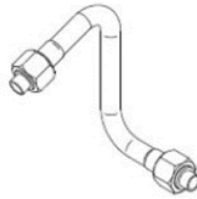

32



33



34



35



36

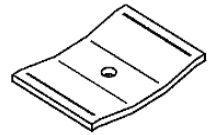

37



38



39



40

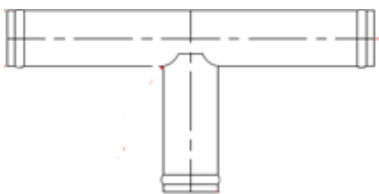

41



42



43



44























45



























46



47

		CC-170
ITEM	DESCRIPTION	REFERENCE NUMBER
1	 Air Conditioning System with fresh air function, 24 V r5500	11113495A
1	 Air Conditioning System with heating and fresh air function, 24 V r5500	11113321A
1	 Air Conditioning System with heating and fresh air function, 24 V r12000	11113474A
2	 Control Panel GL-W101	1101743A
3	 Filterdrier	11113510A
4	 Relay Board GL-W540	1101742A
5	 Startinstart-up module PWM-3 2GB Modul	1100733C
6	 Thermostat	1103377A
7	 Cover r5500	11113322A
7	 Cover r12000	11113634A
8	 relay board GL-W002 Heating Modul	1101744A
9	 Grille Condenser Fan	68055B
10	 Evaporator LH	11113358A
11	 Evaporator RH	11113357A
12	 Axial Fan	68981C
13	 Condenser LH	11113333A
14	 Condenser RH	11113332A
15	 Evaporator blower	1103656A
16	 Receiver Bottle	11112977B
17	 Exp.-Ventil TBEX	11112987A
18	 Temperature Sensor Inside	8402087A
19	 Temperature Sensor Outside	8402084A
20	 Servo Motor 24V	11121648A
21	 High Pressure Switch 24 Bar	1102910B
22	 Low Pressure Switch 1,8 Bar	1102911C

ITEM	DESCRIPTION	REFERENCE NUMBER
23	 2/2-Way Motor Valve Connection . 22	2710801A
24	 Heater core LH	11113355A
25	 Heater core RH	11113356A
26	 Fluid Pipe	11113360A
27	 Evaporator suction line	11113359A
28	 Refrigerant pipe condenser return line	11113337A
29	 Refrigerant pipe compl.	11113344A
30	 Refrigerant pipe compl. receiver / drier	11113342A
31	 Frontbox Pipe	11113327A
32	 Refrigerant pipe LH	11113336A
33	 Refrigerant pipe RH	11113335A
34	 Hose Cond. Coil/Receiver CC170	11119041A
35	 Spacer 22X4X14,2	11113636A
36	 Spacer 28X4X8	11113637A
37	 Bracket Blower	11113351A
38	 Assembling kit relay board	11113542B
39	 Filter	11113749A
40	 Cable harness flap W-H/F	11113379B
-	Cable harness interface	11113381B
-	Cable harness interface W-H/F	11113649B
-	Cable harness Evaporator	11113347B
-	Cable harness Evaporator W-H/F	11113648B
-	Cable harness compressor	11113652B
-	Cable harness condenser	11113334B
-	Cable harness valve W-H/F	11113380B

ITEM	DESCRIPTION	REFERENCE NUMBER
41	 T-piece	11113647A
42	 O-Ring Fitting 180 deg. DN 16 with fill plug	11114014A
43	 O-Ring Fitting 180 deg. DN 20 with fill plug	11114013A
44	 O-Ring Fitting 90 deg. DN 16	11112460A
45	 O-Ring Fitting 90 NW20	11112447A
46	 refrigerant hose NW16 / by the meter GA494	83792A
47	 refrigerant hose NW20 / by the meter GA494	81934A

memos \_\_\_\_\_

\_\_\_\_\_

\_\_\_\_\_

\_\_\_\_\_

\_\_\_\_\_

\_\_\_\_\_

\_\_\_\_\_

\_\_\_\_\_

\_\_\_\_\_

\_\_\_\_\_

\_\_\_\_\_

\_\_\_\_\_

\_\_\_\_\_

\_\_\_\_\_

\_\_\_\_\_

\_\_\_\_\_

\_\_\_\_\_

\_\_\_\_\_

\_\_\_\_\_

\_\_\_\_\_

\_\_\_\_\_

